

Train Platform

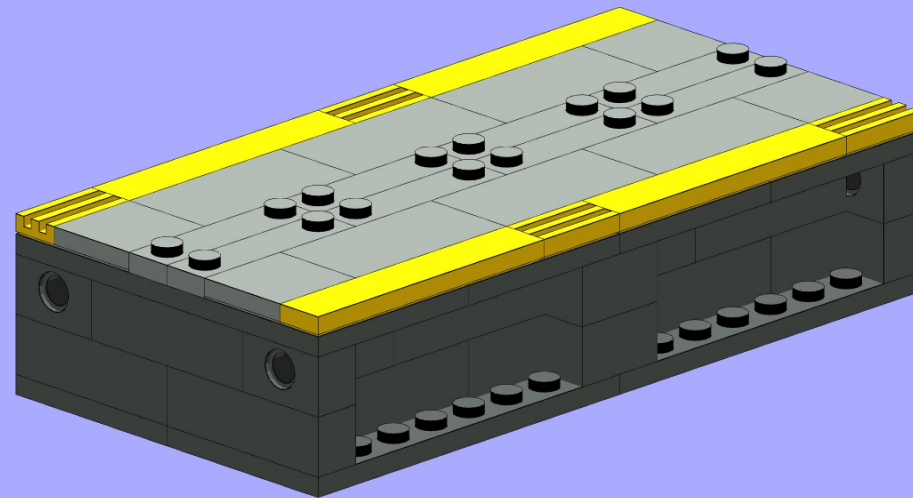

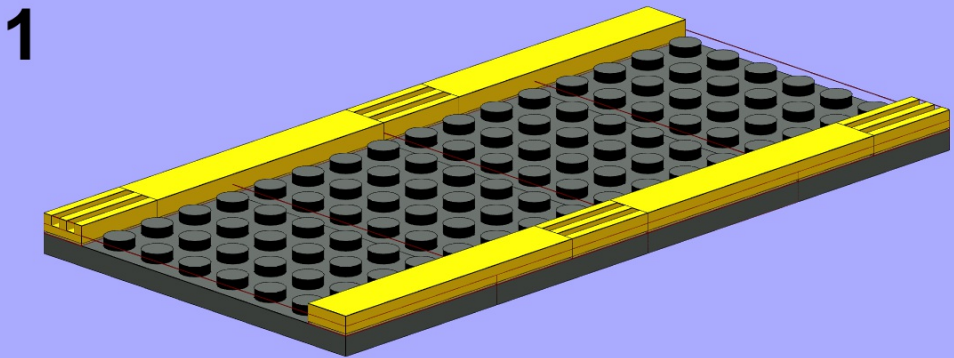

1

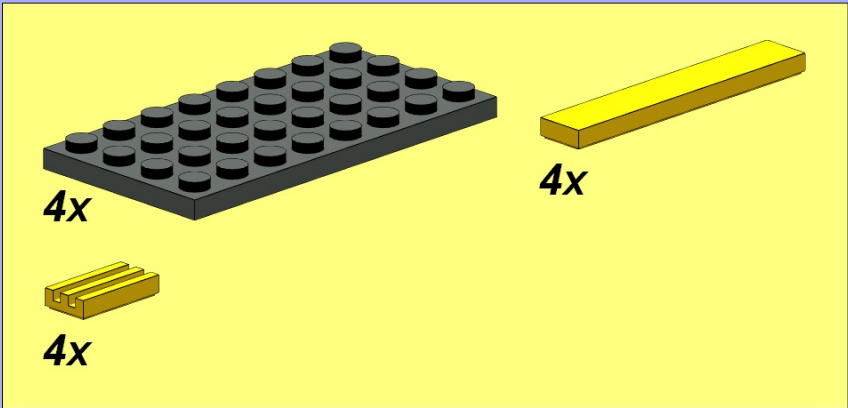
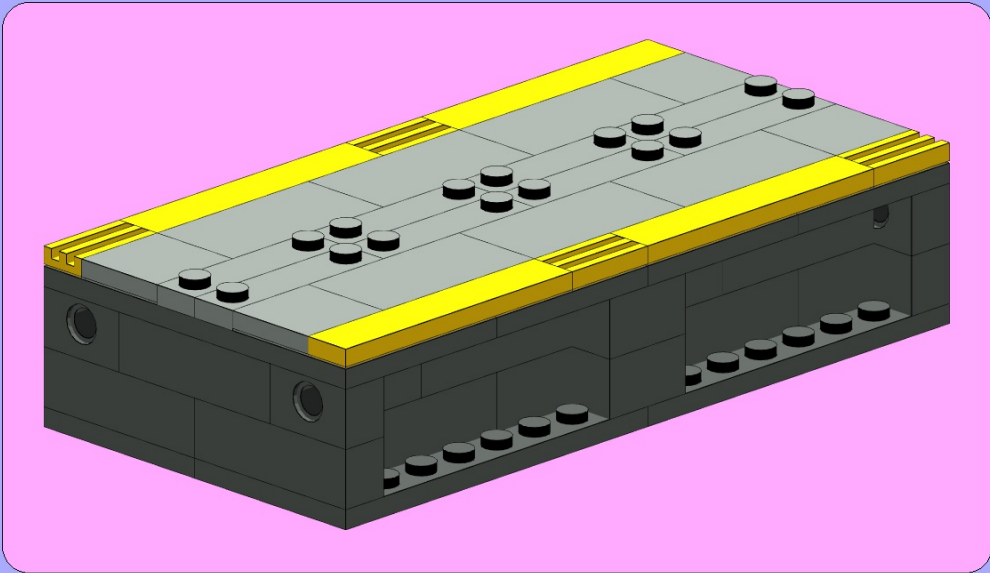
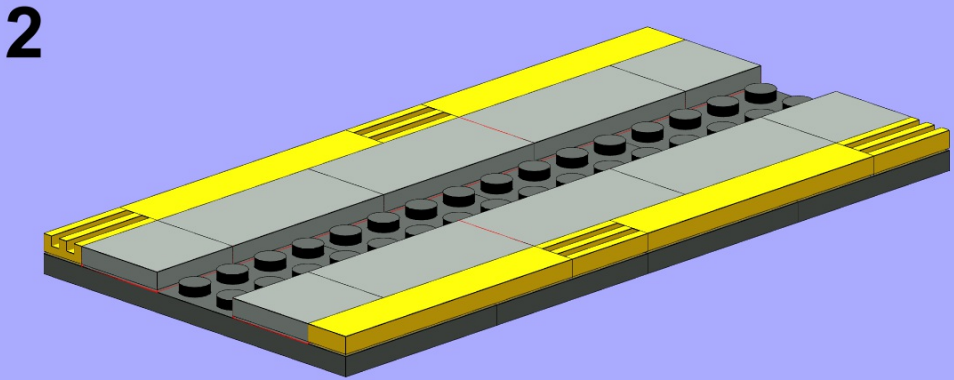
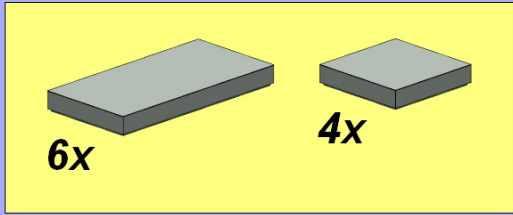

2

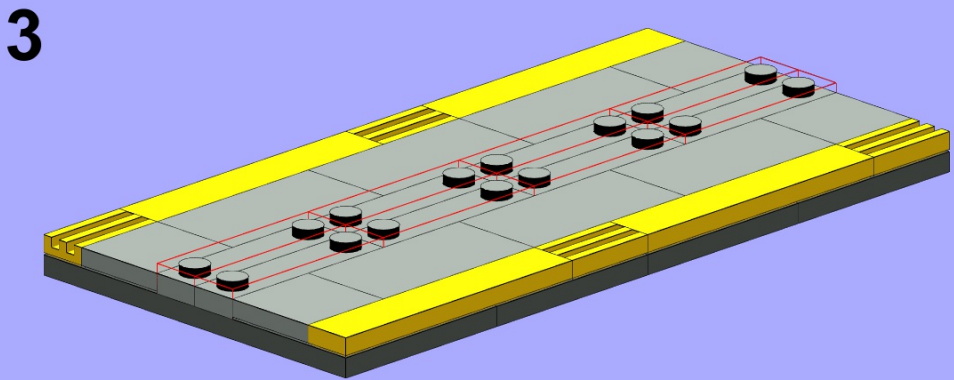
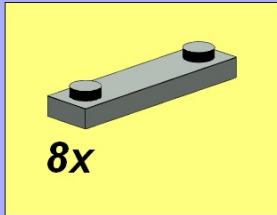

3

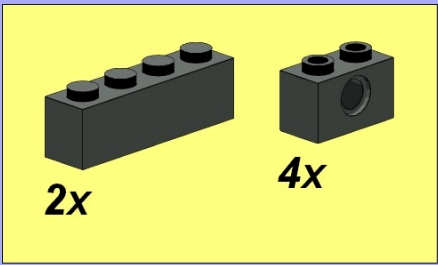

4

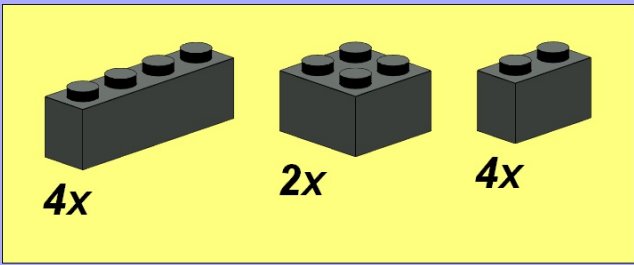
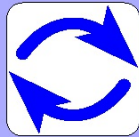
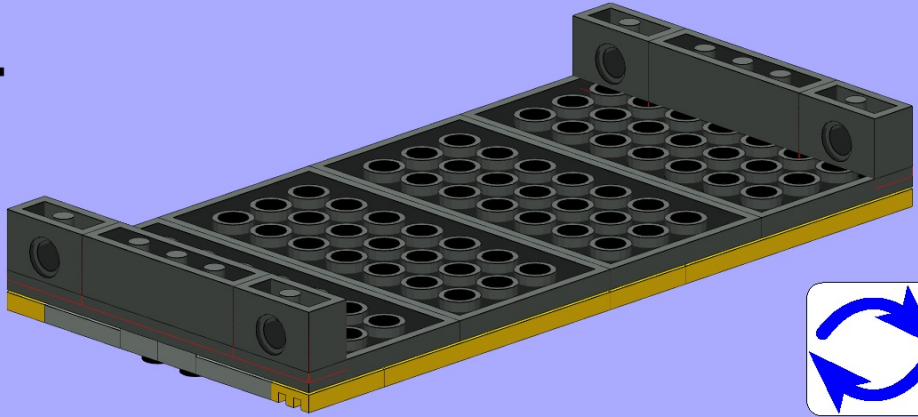

5

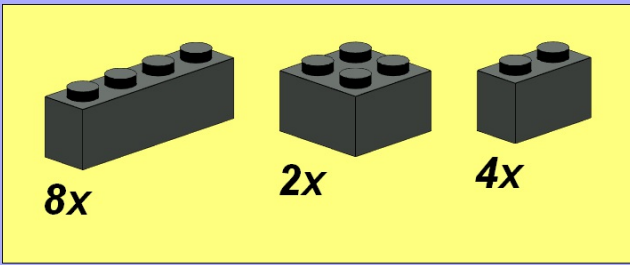
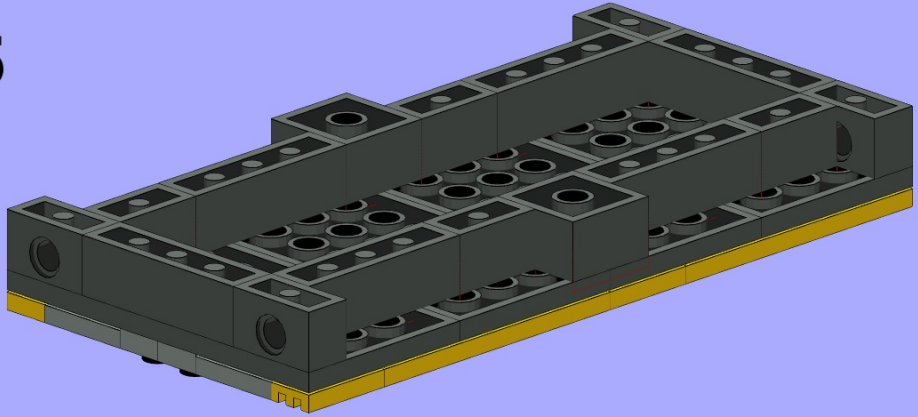

6

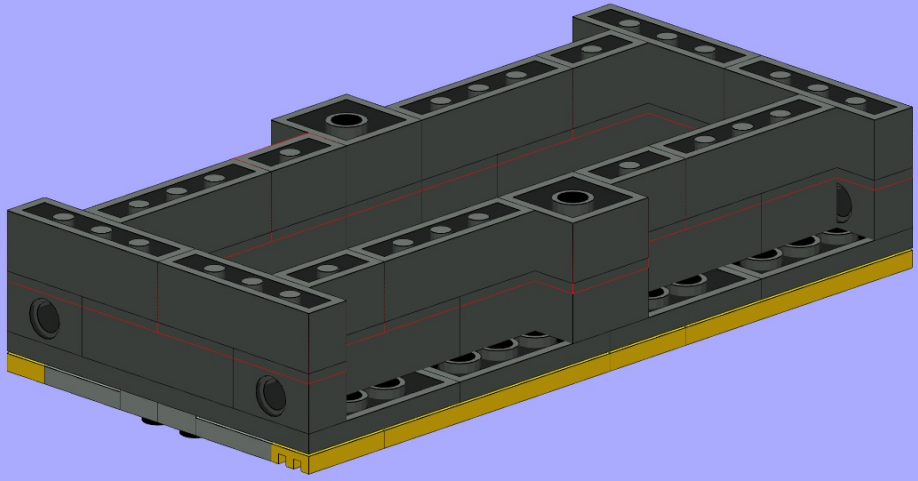

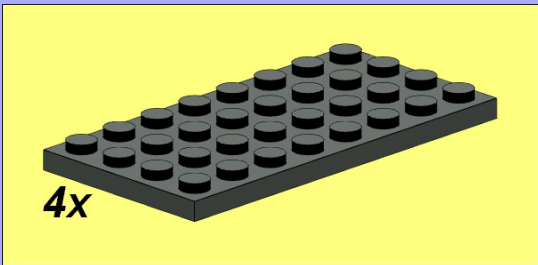

7

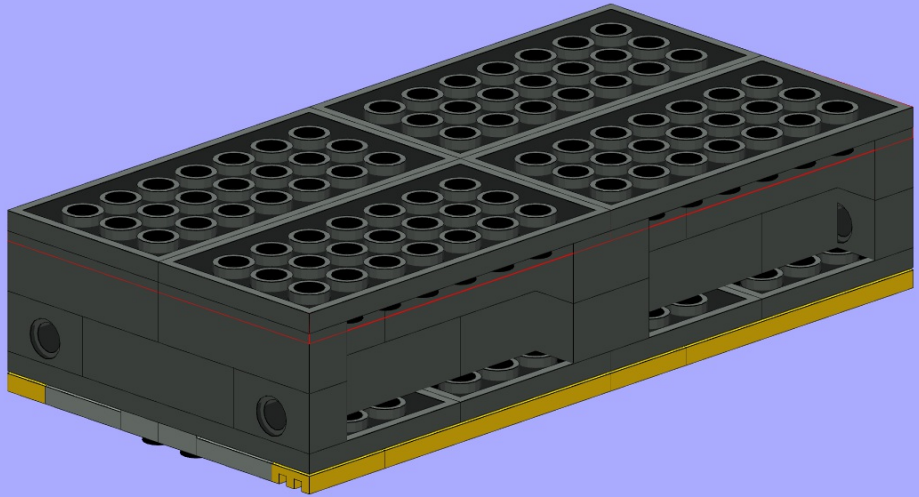

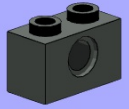

4x

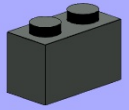

8x

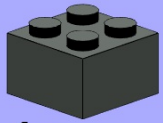

4x

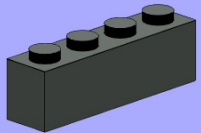

14x

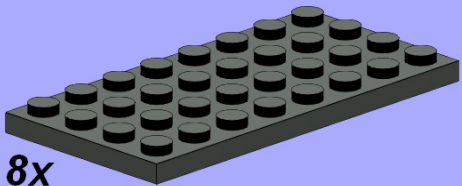

8x

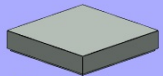

4x

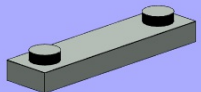

8x

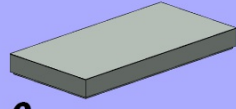

6x

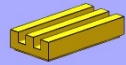

4x

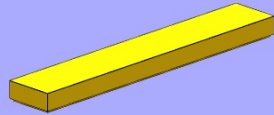

4x